



PRICE LIST

All prices exclude VAT and delivery

PRICE LIST SEPTEMBER 2022

WHAT'S IN THIS PRICE LIST?

General Information	2
CarTeck Sectional Garage Doors	4
CarTeck Garage Door Automation & Lighting	6
CarTeck Super Size Sectional Garage Doors	7
CarTeck GSA Vision Sectional Garage Doors	8
CarTeck SLX Vision Sectional Garage Doors	9
CarTeck Side Hinged Garage Doors	10
Technical Information	12
Spares	16
Hints & Tips CarTeck Sectional Garage Doors	16

What does a pink box mean in the price list?

It contains essential information – make sure you read it!

PRICING

Prices are in £'s Sterling. This price list supersedes and renders null any previous price list.

SIZES

When ordering use metric sizes, imperial conversions are nominal.

TERMS

Comprehensive terms and conditions are on line at:
www.teckentrup.co.uk/terms-conditions

DELIVERY

Delivery:

To company premises FOC.

To site £69 nett.

To Scotland, Highlands and Islands on application.

LEAD-TIMES

Lead times are subject to change and may be affected by the availability of raw materials, border delays and other factors beyond our control.

After placing your order you'll receive a confirmation with the week of delivery.

We work hard to maintain the advised delivery date and any slippage will be notified as soon as we become aware of an issue.

If you need a door for a specific date please call the sales office, we'll do our best to help.

WHAT PERFORMANCE CAN I EXPECT?

As Part of the CE marking process, each product must have its performance provided for a defined set of characteristics. Other characteristics can also be included if relevant to a door's performance, such as security. The following table shows the performance characteristics of each product in our range.

NPD signifies the product has not been measured for this characteristic (NPD - No Performance Determined)

PERFORMANCE CHARACTERISTIC	CarTeck Sectional Garage Doors	CarTeck Super Size Sectional Garage Doors	CarTeck Sectional GSA Vision Garage Doors	CarTeck Sectional SLX Vision Garage Doors	CarTeck Side Hinged Garage Doors
Resistance to Windload EN 12424	Class 2	Class 2	Class 2	Class 2	Class 2
Watertightness EN 12425	Class 2	Class 2	Class 2	Class 2	NPD
Air Permeability EN 12426	Class 2	Class 2	Class 2	Class 2	NPD
Thermal Transmittance EN 13241	1.38 W/m ² k	1.38 W/m ² k	3.3 W/m ² k	3.5 W/m ² k	NPD
Operating Forces (hand Operated) EN 12604	150 N	150 N	150 N	150 N	NPD
Operating Cycles EN 1191	NPD	NPD	NPD	NPD	NPD
Burglar Resistance LPS 1175 Issue 8	NPD	NPD	NPD	NPD	NPD

WARRANTY

The warranty periods below only apply to products that have been correctly installed as per the instructions and have been used, maintained by a Garage Door Specialist and cleaned in accordance with the requirements set out in the operating and maintenance sections of instructions and labels.

CARTECK, SUPER SIZE, GSA VISION & SLX VISION SECTIONAL GARAGE DOORS

2-year manufacturer's guarantee

- on polymer and aluminium window units

5*-year manufacturer's guarantee

- on SLX & GSA Vision windows, rollers, hinges, cable pulleys, cables and standard springs (opening/closing max. 5 times a day)

10-year manufacturer's guarantee

- on panels against rust penetration from inside to outside
- against door panel separation of steel from foam
- on material and manufacturing flaws of all non-moving parts of the frame that are verifiably unusable or whose usability is substantially compromised
- on floor seal, intermediate seals, side seals and lintel seal against rotting

The guarantee does not apply to doors that are subjected to extreme conditions, e.g. corrosive influences resulting from use in a coastal climate with high salt content.

*2 -year for Super Size

CARTECK SIDE HINGED GARAGE DOORS

2-year manufacturer's guarantee

- on window units, hinges, locks, handles and stays (opening/closing max. 5 times a day)

10-year manufacturer's guarantee

- on panels against rust penetration from inside to outside
- against door panel separation of steel from foam
- on material and manufacturing flaws of all non-moving parts of the frame that are verifiably unusable or whose usability is substantially compromised
- on floor seal, intermediate seals and frame seals against rotting

The guarantee does not apply to doors that are subjected to extreme conditions, e.g. corrosive influences resulting from use in a coastal climate with high salt content.

CARTECK DRIVE & MOTOR

*5-year manufacturer's guarantee

- on mechanical defects, material and manufacturing flaws. (opening/closing max. 5 times a day)**

*1 -year for Super Size

** Consumable Items are not included within warranty terms and conditions: hand transmitters, light bulbs, fuses & batteries.

HANDLING

CarTeck Sectional Doors are delivered flat-packed & CarTeck Side Hinged Doors are delivered complete. Both are heavy and require suitable consideration for safe handling.

CarTeck Super Size Sectional, CarTeck GSA Vision & CarTeck SLX Vision are delivered crated. Suitable arrangements for safe handling at delivery and onward transportation must be considered.

CLEANING ON INSTALLATION

After the installation has been completed, clean and dry the door thoroughly inside and out with warm soapy water to remove any grease, dust and metal fragments from the door (these will discolour the door finish if left on the door).

MAINTENANCE

Doors must be maintained as per the supplied Installation, Operating and Maintenance Manual by a Garage Door Specialist. Failure to carry out the required maintenance at the advised interval will invalidate the warranty.

CLEANING

The door should be washed with a car shampoo or similar, every two months, to prevent the build up of dirt, salt, grit and other corrosive substances. If the door is in an area prone to coastal corrosion from airborne salts, the door should be cleaned monthly. Furthermore, cleaning lifting gear with a cloth soaked in a light oil will help to protect your door from corrosion – it must be accepted that salt air is very aggressive and extra care is required.

No caustic, abrasive or corrosive chemicals and substances, flood water, water runoff, or runoff from lead, copper or galvanic metal flashing should be allowed to come into contact with the door.

Ash, cement, dust, animal waste, or foreign substances should be removed immediately. Failure to ensure the door is cleaned and maintained as described will invalidate the doors' warranty.

CARTECK SECTIONAL GARAGE DOORS GSW 40-L

MATCHING SIDE DOORS



For matching side doors see page 10, single leaf prices.

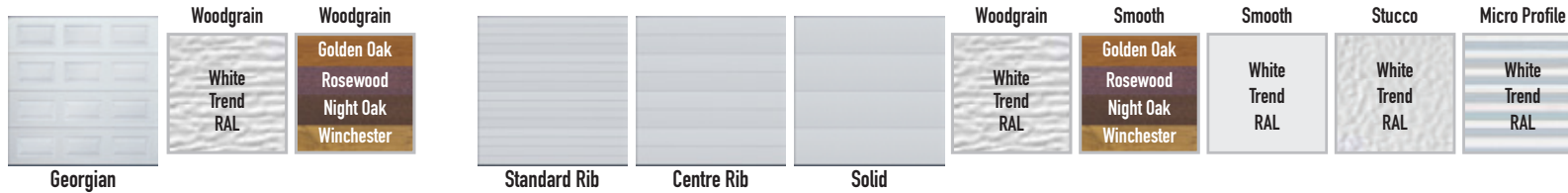

Intermediate height or width or combination:
Next size + £167

Standard Heights

Sections	Standard Widths	Maximum Height mm	Standard Widths																				
			2084 6'10"	2134 7'0"	2235 7'4"	2286 7'6"	2388 7'10"	2438 8'0"	2591 8'6"	2743 9'0"	3048 10'0"	3353 11'0"	3658 12'0"	3962 13'0"	4216 13'10"	4267 14'0"	4420 14'6"	4572 15'0"	4877 16'0"	5182 17'0"	5500 18'0"		
4	1875 6'2"	2050 6'9"	2175 7'2"	White	1400	1400	1402	1402	1488	1488	1608	1753	1898	2042	2187	2331	2378	2427	2511	2529	2674	2818	3107
	1925 6'4"	2084 6'10"	2204 7'3"	Wood/Trend	1538	1538	1552	1552	1640	1640	1763	1920	2075	2233	2389	2547	2700	2711	2774	2937	3095	3250	3565
	2000 6'6"	2125 7'0"	2250 7'4"	RAL	1853	1853	1864	1864	1972	1972	2123	2314	2504	2693	2883	3073	3263	3261	3342	3538	3727	3916	4295
5	2375 7'9"	2750 9'0"		White	1731	1731	1873	1873	1988	1988	2144	2337	2529	2722	2914	3106	3169	3234	3299	3368	3561	3752	4171
	2500 8'2"		Max 5 section height 2835	Wood/Trend	2113	2113	2117	2117	2247	2247	2421	2638	2853	3072	3288	3504	3576	3648	3720	3797	4015	4231	4693
	2625 8'9"			RAL	2317	2317	2333	2333	2468	2468	2656	2893	3129	3368	3604	3841	4079	4076	4176	4420	4656	4893	5416
6	2875 9'5"			White	2490	2490	2495	2495	2648	2648	2852	3108	3366	3621	3876	4134	4218	4303	4387	4477	4584	-	-
	3000 9'9"			Wood/Trend	2808	2808	2813	2813	2989	2989	3217	3505	3792	4082	4370	4656	4753	4847	4941	5045	5157	-	-
				RAL	3145	3145	3162	3162	3326	3326	3547	3834	4118	4403	4689	4971	5256	5255	5372	5665	5785	-	-

FRAME LEG/HEADER COLOUR

Door price includes white frame legs and header.
For colour matched frame legs & header add:
Please specify back fix frame or between fix (no holes) frame

Colour	White	Wood/Trend	RAL	0	0	0	0	0	0	0	0	0	0	0	0	0	0	0	0	0	0	0
White	0	0	0	0	0	0	0	0	0	0	0	0	0	0	0	0	0	0	0	0	0	0
Wood/Trend	67	68	71	72	75	76	79	86	95	104	112	122	131	132	136	142	150	158	170			
RAL	292	296	303	309	314	318	330	343	365	388	409	432	453	456	468	480	490	503	550			

WINDOWS

Polymer Windows (type 1 Rectangle)

Number of windows	Number of windows																			
	3	3	3	3	3	3	3	3	3	4	4	4	5	5	5	5	5	6	6	7
White	384	384	384	384	384	384	384	384	384	540	540	540	675	675	675	675	675	810	810	945
Trend / RAL / Wood Design	504	504	504	504	504	504	504	504	504	708	708	708	885	885	885	885	885	1062	1062	1239

BETWEEN FIX ACCESSORIES

Accessory	Width	Width	
		<=3000mm	>3000mm
85mm Frame Leg 3D Profile Kit	White	126	126
	Wood/Trend	126	126
	RAL	208	208
85mm x 12mm x 3000mm 3D Legs	White	208	276
	Wood/Trend	208	276
	RAL	331	440
85/120mm Frame 3D Profile Kit	White	208	276
	Wood/Trend	208	276
	RAL	331	440
85mm x 12mm x 3000mm 3D Legs 120mm x 12mm x 3000mm 3D Header	White	229	303
	Wood/Trend	249	331
	RAL	331	440
120mm Frame 3D Profile Kit	White	229	303
	Wood/Trend	249	331
	RAL	331	440
120mm x 12mm x 3000mm 3D Legs & 3D Header	White	248	334
	Wood/Trend	269	362
	RAL	332	469
85mm 3D Frame Leg & Additional Door Header	White	248	334
	Wood/Trend	269	362
	RAL	332	469
5mm x 12mm x 3000mm 3D Legs Additional Door Header to Width of Door	White	229	303
	Wood/Trend	249	331
	RAL	331	440
70mm Angle 3D Renovating Profile	White	229	303
	Wood/Trend	249	331
	RAL	331	440
Kit 70mm x 12mm x 3000mm 3D Legs & 3D Header	White	229	303
	Wood/Trend	249	331
	RAL	331	440

TREND COLOURS

Flame Red RAL 3000	Fir Green RAL 6009	White Aluminium RAL 9006
Window Grey RAL 7040	Anthracite Grey RAL 7016	Grey Aluminium RAL 9007
Quartz Grey RAL 7039	Light Grey RAL 7035	Slate Grey RAL 7015
Steel Blue RAL 5011	Umbr Grey RAL 7022	Cream RAL 9001
Anthracite Textured RAL 7016	Ice Crystal Grey Aluminium	Jet Black RAL 9005
Moss Green RAL 6005	Sepia Brown RAL 8014	TT 703 A special satin metallic effect - grey with micaeous iron ore particles.

Colours
Where doors are exposed to direct sunlight, dark colours should be avoided.
RAL references for colours are provided as a guide only to the nearest similar RAL colour. Colours will not match to other RAL finishes due to different coating processes, gloss levels, substrates and textures. Similarly, special RAL, BS, wood effects or other colours will not be a precise match.
Colours shown are limited in accuracy by the printing process - samples should always be requested.
If you are matching to other finishes, particularly wood effects such as rosewood, golden oak, night oak or Winchester, always request a sample.

POPULAR OPTIONS

ACCESSORIES AND OPTIONS	
Manual locking including detent (factory prepared) 5000mm Max	£149 each
Manual locking including detent (onsite with template) 5000mm Max	£80 each
L shaped fixing strap kit	£24 pair
Between reveal fitting bracket kit (When using a between the reveal fitting kit, the sideroom required is 85mm)	£76 each
Between reveal twist fix header bracket (2x) kit (Recommended for doors over 3000mm wide)	£32 each
Horizontal Track cut down charge	£167 per set

For the full range of spares/accessories see back page.

Georgian Features

Georgian design door widths of 2060mm and below have 2 features and come with an increase lead time - call the office for details.

Frame Legs, Headers & 3D Profiles

Frame legs/header - 85mm/115mm smooth & white as standard. For Trend, RAL or Wood Design, add the uplift to the white price.

Wood Design frame legs, headers & 3D profiles in Night Oak & Rosewood are finished in a complimentary painted wood effect finish but will not match precisely. Golden Oak and Winchester are finished in a complementary flat colour to RAL 8014. TT9016 Bling White frame legs, headers & 3D profiles are finished in RAL 9016.

All frame Legs, headers & 3D profiles are available in smooth finish only.

Between fix (No Holes) frames up to 2250mm high maximum.

POLYMER WINDOWS

WINDOWS - POLYMER DOUBLE GLAZING

Windows construction: Polymer casement with polymer (Styrene Acrylonitrile) double glazed unit.

Georgian



Standard Rib, Centre Rib & Solid

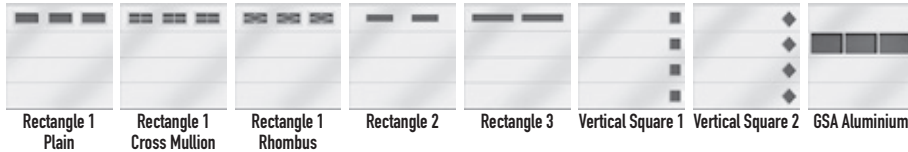

Style	Overall Size	Colour / Finish	Price
Rectangle 1	610 X 270	White	£135 each
Rectangle 1	610 X 270	Trend/Ral/Wood design	£177 each
Rectangle 2	680 X 210	White	£135 each
Rectangle 2	680 X 210	Trend/Ral/Wood design	£177 each
Rectangle 3	980 X 140	White	£162 each
Rectangle 3	980 X 140	Trend/Ral/Wood design	£212 each
Square 1 & 2	270 x 270	White	£135 each
Square 1 & 2	270 x 270	Trend/Ral/Wood design	£177 each
GSA Aluminium Window Section	per linear m	White/Trend	£492 per m
GSA Aluminium Window Section	per linear m	Ral/Wood design	£738 per m

All polymer windows are available with these glazing options:



Clear



Frosted



Satin

Polymer Windows

To price for windows fitted vertically down the door; square type 1 & 2, match windows to number of sections ie 4 sections = 4 windows).

Selected Trend colours & wood design windows are finished in a complementary flat colour for Golden Oak (RAL8003), Rosewood (RAL8016), Night Oak (RAL8014), Winchester (RAL8001), Textured Anthracite (RAL7016), Ice Crystal Grey Aluminium (RAL9007) and TT9016 Bling White (RAL9016).

The surrounds on aluminium GSA window sections are finished in a smooth finish.

Window frame colour shade and surface lustre will show a variance from the panel finish as the base material and coating methods are different.

Polymer glazing in Georgian doors and Type 2 rectangle is 16mm thick. All other polymer glazing is 20mm thick.

EXTRA OPTIONS

EXTRA TOUCHES

PET FLAP

£45 fitting charge*

*Customer supplied

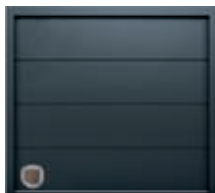

SPY HOLE

£52

LETTER BOX

From £78



ALUMINIUM WINDOWS & DECALS

ALUMINIUM WINDOWS - POLYMER DOUBLE GLAZING

Alpha
280mm x 280mm

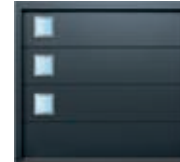

PRICE PER WINDOW

£333

Sigma
610mm x 200mm

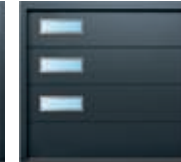

Zeta
ø280mm

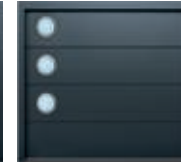

Gamma
534mm x 344mm

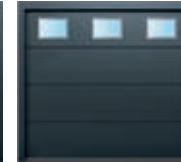

Kappa
1860mm x 180mm



PRICE PER WINDOW

£800

Athena
406mm x 203mm

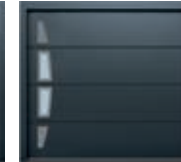

Versus
900mm x 1000mm



Satin



Clear

All aluminium windows are available with these glazing options (satin is supplied as standard).

ALUNOX DECALS

Factory bonded alunox decals. Decals can be positioned to requested positions, however, popular arrangements are shown here.

Access 1
431mm x 40mm

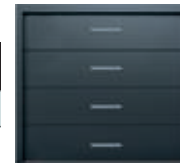

Access 2
430mm x 40mm

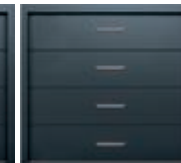

Access 3
215mm x 40mm

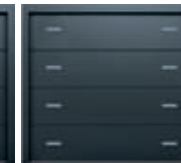

Access 4
400mm x 86mm

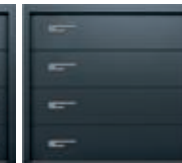

Access 5
180mm x 180mm

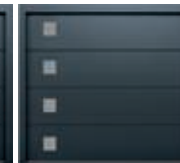

PRICE PER DECAL

£57

Access 6
70mm x 70mm

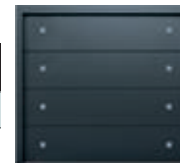

Access 7
150mm x 150mm



Access 8
194 mm x 194 mm

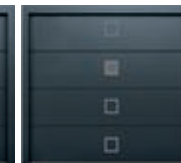

Access 9
436mm x 40mm

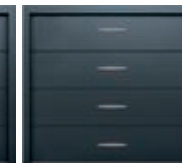

Access 10
431mm x 13mm

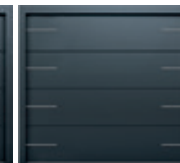

PRICE PER DECAL

£57

Writing
100mm 200mm

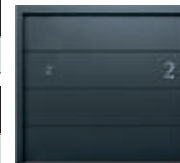

PRICE PER DECAL

100mm £52

PRICE PER DECAL

200mm £57

DOOR DRIVES

CarTeck DRIVE⁺

CARTECK DRIVE



Drive 500 / 600



Drive Pro 500 / 600

Drives require 140mm headroom. To fit within 120mm use the Spacer Bar Suspension Plate that lowers the rear spacer bar by 40 mm

Drive 500Nm & 2 x Pearl Twin	£394
Drive Pro 500Nm & 2 x Pearl Twin	£449
Drive 600Nm & 2 x Pearl	£429
Drive Pro 600Nm & 2 x Pearl	£473
Rail extension 1096mm (heights greater than 2375mm) add	£107
Spacer bar suspension plate (for 120mm headroom)	£32



CARTECK DRIVE ACCESSORIES

Post & packing may apply to accessories not ordered with a door

Description	Price	Compatibility	
		500	600
2-function handheld transmitter „Pearl Twin“	£70	•	•
4-function handheld transmitter „Pearl“	£82	•	•
3-function handheld transmitter „Pearl status“	£107	•	•
4-function handheld transmitter „Pearl vibe“	£107	•	•
Holding clip for pearl transmitter for sun shield	£14	•	•
Holder Pearl for mounting pearl transmitter white or black	£20	•	•
868 MHz Radio receiver (2-channel)	£150	•	•
Access Pack 1: Keypad (Courier)	£123	•	•
Access Pack 3: Surface mounted keypad	£420	•	•
Wired 3 function internal wall station	£52	•	•
Access Pack 2: wireless 2 function wall switch white or grey	£107	•	•
Safety Pack 1 Photo cell kit (Includes mounting kit if required)	£137	•	•
Additional light strip attaches to control unit	£57	•	•
Ambience pack 1: light strip & motion sensor	£116	•	•
Ambience pack 2: relay to control lighting	£38	•	•
Parking Pack 1: position laser & reflector	£89	•	•
Parking Pack 2: humidity sensor	£34	•	•
Security pack 1: lock & alarm buzzer	£92	•	•
Security pack 2: alarm buzzer & lighting control relay	£120	•	•
Power pack: battery backup	£216	•	•
Smart pack: output module for smart home integration	£150	•	•
External release for garages without a second entrance	£57	•	•
Special 101 towing arm bracket	£123	•	•

NEW!

Featured Accessories



1500 lumen/m neutral white 4000K light.

Ambience Pack 4

Compatibility

	Price	500	600
Light bars with stand-alone power supply and motion detector			
Width up to 2220mm	£242	•	•
Width up to 3205mm	£305	•	•
Width up to 4190mm	£368	•	•
Width up to 5528mm	£462	•	•
Link to Amazon Alexa - Smart Home	£95	•	•

NEW!

Ambience Pack 3 LED strips for tracks and spacer bar

Price 500 600

3rd generation ambience pack 3: 2 x threads (left/right) 2m and 1m of LED lights, motion sensor & remote control	£246	•	•
--	------	---	---



SOMweb Smart Phone Module with Safety Photo Cells

Allows control of up to 10 doors

£437 • •



CARTECK MOTOR

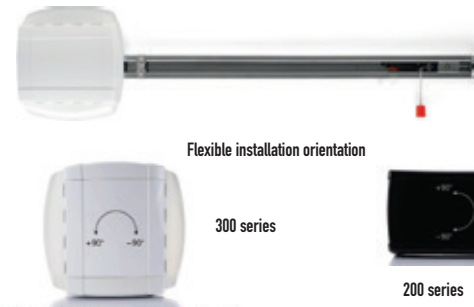

Flexible installation orientation

300 series

200 series

Add your rail

Motor Head	Price	3286mm	3536mm	4296mm
260	£276	+£105	+£165	+£198
270	£323	+£105	+£165	+£198
280	£393	+£105	+£165	+£198
360	£420	+£105	+£165	+£198
370	£488	+£105	+£165	+£198
380	£664	+£105	+£165	+£198

CARTECK MOTOR ACCESSORIES

Post & packing may apply to accessories not ordered with a door

Battery back up for 300 series up to 5 cycles	£247	Photocells	£137
Transmitter 2 channel	£79	External receiver 1 channel	£197
Transmitter 4 channel	£94	Digital key pad	£165
Transmitter 3 channel bidirectional	£133	Push button wireless	£75
External release for garages without a second entrance	£57	Special 101 towing arm bracket	£123

SUPER SIZE SECTIONAL GARAGE DOORS

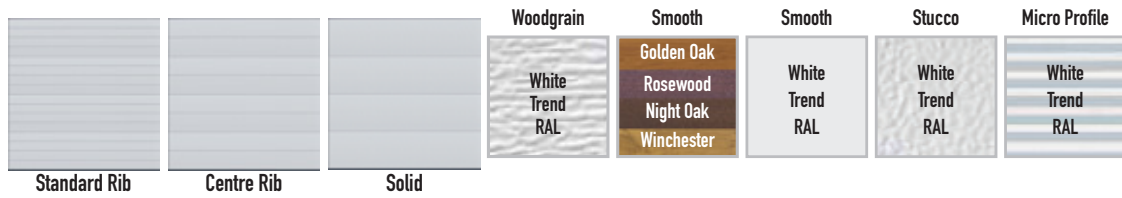

Pricing includes Motor:

CarTeck DRIVE Pro 1100 rail operator or Teckentrup Direct Drive, optical safety edge, photocells & 2 transmitters

Heights up to:

Widths up to:

Sections	Height	Operator	Finish	6000	6500	7000	7500	8000	
4	2280	Rail Operator	White/Wood/Trend RAL	6375	7436	-	-	-	
		Direct Drive	White/Wood/Trend RAL	7158	8143	9160	9569	9984	
5	2835	Direct Drive	White/Wood/Trend RAL	7752	8934	10115	10593	11070	
			White/Wood/Trend RAL	8562	9812	11061	11606	12151	
6	3000	Direct Drive	White/Wood/Trend RAL	8025	9326	10592	11103	11616	
			White/Wood/Trend RAL	8909	10284	11623	12209	12795	
				Number of windows	8	8	9	9	10
Polymer Windows (type 1 Rectangle)				White	1080	1080	1215	1215	1350
				Trend/Wood/RAL	1426	1426	1593	1593	1770

OPTIONS

Low Headroom up to 6500mm	£ 389
Low Headroom 6501mm - 7750mm	£ 537

TREND COLOURS

Flame Red RAL 3000	Fir Green RAL 6009	White Aluminium RAL 9006
Window Grey RAL 7040	Anthracite Grey RAL 7016	Grey Aluminium RAL 9007
Quartz Grey RAL 7039	Light Grey RAL 7035	Slate Grey RAL 7015
Steel Blue RAL 5011	Umbra Grey RAL 7022	Cream RAL 9001
Anthracite Textured RAL 7016	Ice Crystal Grey Aluminium	Jet Black RAL9005
Moss Green RAL 6005	Sepia Brown RAL 8014	TT 703 A special satin metallic effect - gray with micaeous iron ore particles.

Colours

Where doors are exposed to direct sunlight, dark colours should be avoided. RAL references for colours are provided as a guide only to the nearest similar RAL colour. Colours will not match to other RAL finishes due to different coating processes, gloss levels, substrates and textures. Similarly, special RAL, BS, wood effects or other colours will not be a precise match.

Colours shown are limited in accuracy by the printing process - samples should always be requested.

If you are matching to other finishes, particularly wood effects such as rosewood, golden oak, night oak or Winchester, always request a sample.

POLYMER WINDOWS

WINDOWS - POLYMER DOUBLE GLAZING

Windows construction: Polymer casement with polymer (Styrene Acrylonitrile) double glazed unit.

Style	Overall Size	Colour / Finish	Price per Window
Rectangle 1	610 X 270	White	£135 each
		Trend/Ral/Wood design	£177 each
Rectangle 2	680 X 210	White	£135 each
		Trend/Ral/Wood design	£177 each
Rectangle 3	980 X 140	White	£162 each
		Trend/Ral/Wood design	£212 each
Square 1 & 2	270 x 270	White	£135 each
		Trend/Ral/Wood design	£177 each
GSA Aluminium Window Section	per linear m	White/Trend	£492 per m
		Ral/Wood design	£738 per m

Polymer Windows

To price for windows fitted vertically down the door; square type 1 & 2, match windows to number of sections ie 4 sections = 4 windows).

Selected Trend colours & wood design windows are finished in a complementary flat colour for Golden Oak (RAL8003), Rosewood (RAL8016), Night Oak (RAL8014), Winchester (RAL8001), Textured Anthracite (RAL7016), Ice Crystal Grey Aluminium (RAL9007) and TT9016 Bling White (RAL9016).

The surrounds on aluminium GSA window sections are finished in a smooth finish.

Window frame colour shade and surface lustre will show a variance from the panel finish as the base material and coating methods are different.

Polymer glazing in Type 2 rectangle is 16mm thick. All other polymer glazing is 20mm thick.

All polymer windows are available with these glazing options:



Clear



Frosted



Satin



Teckentrup Direct Drive motors must have 13 amp supply direct to the consumer unit.



CARTECK SECTIONAL GARAGE DOORS GSA VISION

NEW!



GSA Vision Options

Sectional door panels made from hollow aluminium profiles, 40mm profile depth with 20mm scratch resistant, polymer double glazing.



Clear



Satin



Frosted

MATCHING SIDE DOORS



*Maximum Over-Frame Size		Single leaf Up to 1250
Height*	Width*	
Up to 2050	Trend	3650
4 Section	RAL	4266
Up to 2204	Trend	3735
4 Section	RAL	4352
Up to 2320	Trend	3825
5 Section*	RAL	4440

Doors are prepared for automation as standard (manual locking not available)

Heights up to:

Sections	Height	White/Trend	RAL	Widths up to:																	
				2084 6'10"	2134 7'0"	2235 7'4"	2286 7'6"	2388 7'10"	2438 8'0"	2591 8'6"	2743 9'0"	3048 10'0"	3353 11'0"	3658 12'0"	3962 13'0"	4216 13'10"	4267 14'0"	4420 14'6"	4572 15'0"	4877 16'0"	5182 17'0"
4	2280	White/Trend	5310	5310	5310	5391	5465	5918	5918	5928	6244	6426	6893	7055	7209	7373	7373	7830	8221	8385	8539
		RAL	6288	6288	6288	6377	6464	6464	7026	7037	7392	7589	8163	8333	8510	8689	9252	9264	9669	9847	10010
5	2835	White/Trend	6487	6487	6487	6587	6676	7244	7244	7253	7647	7838	8418	8619	9061	9264	9264	9834	10034	10236	10428
		RAL	7710	7710	7710	7819	7928	7928	8630	8640	9080	9290	10005	10216	10687	10909	11611	11624	11842	12064	12266
6	3000	White/Trend	7622	7622	7622	7741	7850	8531	8531	8539	9007	9498	10191	10431	10657	10897	10897	11581	11818	-	-
		RAL	9089	9089	9089	9221	9350	9350	10194	10201	10728	11243	12096	12348	12609	12875	13716	13728	13990	-	-

Number of windows	2	2	2	3	3	3	4	4	4	4	5	5	5	5	5	6	6	6	6
	2250mm			2500mm			3500mm				4500mm				5500mm				

FRAME LEG/HEADER COLOUR

Door price includes white frame legs and header. For colour matched frame legs & header add: Please specify back fix frame or between fix (no holes) frame

Colour	0	0	0	0	0	0	0	0	0	0	0	0	0	0	0	0	0	0	0	0
White	0	0	0	0	0	0	0	0	0	0	0	0	0	0	0	0	0	0	0	0
Trend	67	68	71	72	75	76	79	86	95	104	112	122	131	132	136	142	150	158	170	
RAL	292	296	303	309	314	318	330	343	365	388	409	432	453	456	468	480	490	503	550	

Frame Legs, Headers & 3D Profiles

Frame legs/header - 85mm/115mm smooth & white as standard. All frame Legs, headers & 3D profiles are available in smooth finish only. Between fix (No Holes) frames up to 2250mm high maximum.

BETWEEN FIX ACCESSORIES

	Width	<=3000mm	>3000mm
85mm Frame Leg 3D Profile Kit	White	126	126
	Trend	126	126
	RAL	208	208
85/120mm Frame 3D Profile Kit	White	208	276
	Trend	208	276
	RAL	331	440
120mm Frame 3D Profile Kit	White	229	303
	Trend	249	331
	RAL	331	440
85mm 3D Frame Leg & Additional Door Header	White	248	334
	Trend	269	362
	RAL	332	469
70mm Angle 3D Renovating Profile	White	229	303
	Trend	249	331
	RAL	331	440

TREND COLOURS

White RAL 9016	Fir Green RAL 6009	White Aluminium RAL 9006
Flame Red RAL 3000	Anthracite Grey RAL 7016	Grey Aluminium RAL 9007
Window Grey RAL 7040	Light Grey RAL 7035	Slate Grey RAL 7015
Quartz Grey RAL 7039	Umbra Grey RAL 7022	Cream RAL 9001
Steel Blue RAL 5011	Sepia Brown RAL 8014	Jet Black RAL 9005
Moss Green RAL 6005	NOTE: Flat colours only	

Colours

Where doors are exposed to direct sunlight, dark colours should be avoided. RAL references for colours are provided as a guide only to the nearest similar RAL colour. Colours will not match to other RAL finishes due to different coating processes, gloss levels, substrates and textures. Similarly, special RAL, BS or other colours will not be a precise match. Colours shown are limited in accuracy by the printing process - samples should always be requested.

POPULAR OPTIONS

ACCESSORIES AND OPTIONS

L shaped fixing strap kit	£24 pair
Between reveal fitting bracket kit (When using a between the reveal fitting kit, the sideroom required is 85mm)	£76 each
Between reveal twist fix header bracket (2x) kit (Recommended for doors over 3000mm wide)	£32 each
Horizontal Track cut down charge	£167 per set

For the full range of spares/accessories see back page.

CARTECK SECTIONAL GARAGE DOORS SLX VISION

NEW!



Full width glazing up to 3250mm wide (no mullions)



Single mullion over 3250mm wide

Doors are prepared for automation as standard (manual locking not available)

Heights up to:

Sections	Height	White/Trend	RAL	Widths up to:													
				2084	2134	2235	2286	2388	2438	2591	2743	3048	3353	3658	3962	4000	
				Maximum Height mm													
4	2280	White/Trend	5310	5310	5310	5391	5465	5918	5918	5928	6244	6426	6893	7055	7209		
		RAL	6288	6288	6288	6377	6464	6464	7026	7037	7392	7589	8163	8333	8510		
5	2835	White/Trend	6487	6487	6487	6587	6676	7244	7244	7253	7647	7838	8418	8619	9061		
		RAL	7710	7710	7710	7819	7928	7928	8630	8640	9080	9290	10005	10216	10687		
6	3000	White/Trend	7622	7622	7622	7741	7850	8531	8531	8539	9007	9498	10191	10431	10657		
		RAL	9089	9089	9089	9221	9350	9350	10194	10201	10728	11243	12096	12348	12609		
				Number of windows													
				1	1	1	1	1	1	1	1	2	2	2	2		
				3250mm													

FRAME LEG/HEADER COLOUR

Door price includes white frame legs and header. For colour matched frame legs & header add: Please specify back fix frame or between fix (no holes) frame

Colour	0	0	0	0	0	0	0	0	0	0	0	0	0	0
White	0	0	0	0	0	0	0	0	0	0	0	0	0	0
Trend	67	68	71	72	75	76	79	86	95	104	112	122	131	
RAL	292	296	303	309	314	318	330	343	365	388	409	432	453	

BETWEEN FIX ACCESSORIES

Accessory	Width	Width	
		<=3000mm	>3000mm
85mm Frame Leg 3D Profile Kit	White	126	126
	Trend	126	126
	RAL	208	208
85mm x 12mm x 3000mm 3D Legs	White	208	276
	Trend	208	276
	RAL	331	440
120mm Frame 3D Profile Kit	White	229	303
	Trend	249	331
	RAL	331	440
120mm x 12mm x 3000mm 3D Legs & 3D Header	White	248	334
	Trend	269	362
	RAL	332	469
85mm 3D Frame Leg & Additional Door Header	White	229	303
	Trend	249	331
	RAL	331	440
70mm Angle 3D Renovating Profile	White	229	303
	Trend	249	331
	RAL	331	440
Kit 70mm x 12mm x 3000mm 3D Legs & 3D Header	White	229	303
	Trend	249	331
	RAL	331	440

TREND COLOURS

White RAL 9016	Fir Green RAL 6009	White Aluminium RAL 9006
Flame Red RAL 3000	Anthracite Grey RAL 7016	Grey Aluminium RAL 9007
Window Grey RAL 7040	Light Grey RAL 7035	Slate Grey RAL 7015
Quartz Grey RAL 7039	Umbr Grey RAL 7022	Cream RAL 9001
Steel Blue RAL 5011	Sepia Brown RAL 8014	Jet Black RAL 9005
Moss Green RAL 6005	NOTE: Flat colours only	

Colours

Where doors are exposed to direct sunlight, dark colours should be avoided. RAL references for colours are provided as a guide only to the nearest similar RAL colour. Colours will not match to other RAL finishes due to different coating processes, gloss levels, substrates and textures. Similarly, special RAL, BS or other colours will not be a precise match. Colours shown are limited in accuracy by the printing process - samples should always be requested.

VISION OPTIONS

Sectional door panels made from hollow aluminium profiles, 40mm profile depth with 20mm scratch resistant, polymer double glazing.



Clear

Satin

Frosted



Green Tint
70% transmission (approx)

Brown Tint
50% transmission (approx)

Grey Tint
43% transmission (approx)

Frame Legs, Headers & 3D Profiles

Frame legs/head - 85mm/115mm smooth & white as standard. All frame Legs, headers & 3D profiles are available in smooth finish only. Between fix (No Holes) frames up to 2250mm high maximum.

POPULAR OPTIONS

ACCESSORIES AND OPTIONS

L shaped fixing strap kit	£24 pair
Between reveal fitting bracket kit (When using a between the reveal fitting kit, the sideroom required is 85mm)	£76 each
Between reveal twist fix header bracket (2x) kit (Recommended for doors over 3000mm wide)	£32 each
Horizontal Track cut down charge	£167 per set

For the full range of spares/accessories see back page.

CARTECK SIDE HINGED GARAGE DOORS GSW 40-L

All styles available 1/2 - 1/2 or Asymmetric

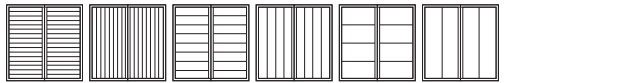
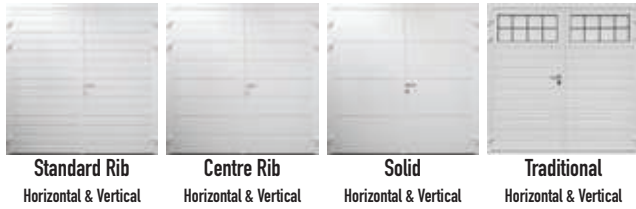

*Maximum Over-Frame Size	Single leaf				Double leaf			
	Up to	Up to	Up to	Up to	Up to	Up to	Up to	Up to
Height* / Width*	1250	2286	2438	2500	1250	2286	2438	2500

Up to	Section	Standard Rib				Centre Rib				Solid				Traditional										
		White	Wood/Trend	RAL	Price	White	Wood/Trend	RAL	Price	White	Wood/Trend	RAL	Price	White	Wood/Trend	RAL	Price							
Up to 2050	4 Section	1637	2003	2236	2347	2744	3010	2454	2852	3119	2570	2967	3232	2025	2390	2656	3935	4464	4730	4066	4464	4609	4875	
Up to 2204	4 Section	1720	2085	2318	2454	2852	3119	2565	2963	3228	2691	3089	3353	2108	2472	2705	4042	4440	4838	4175	4572	4995	4332	4730
Up to 2320	4 Section	1806	2173	2405	2570	2967	3232	2691	3089	3353	2863	3261	3525	2194	2559	2791	4156	4554	4966	4301	4699	5166	4503	4901
Up to 2359	5 Section																							

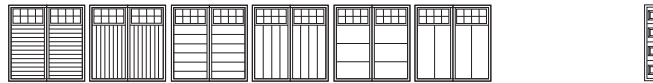

*Maximum Over-Frame Size	Single leaf				Double leaf			
	Up to	Up to	Up to	Up to	Up to	Up to	Up to	Up to
Height* / Width*	1250	2286	2438	2500	1250	2286	2438	2500

Up to	Section	Woodgrain				Smooth				Stucco				Micro Profile								
		White	Wood/Trend	RAL	Price	White	Wood/Trend	RAL	Price	White	Wood/Trend	RAL	Price	White	Wood/Trend	RAL	Price					
Up to 2050	4 Section	2025	2390	2656	3935	4332	4597	4066	4464	4730	4875	1802	2169	2400	2565	2963	3348	2809	3207	3473		
Up to 2204	4 Section	2108	2472	2705	4042	4440	4838	4175	4572	4995	4332	4730	1893	2258	2491	2685	3083	2809	3207	3338	3604	
Up to 2320	4 Section	2194	2559	2791	4156	4554	4966	4301	4699	5166	4503	4901	1987	2352	2585	2809	3207	3338	3478	3744		
Up to 2359	5 Section																					

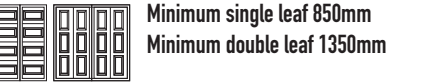
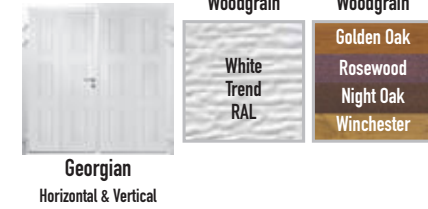

*Maximum Over-Frame Size	Single leaf				Double leaf			
	Up to	Up to	Up to	Up to	Up to	Up to	Up to	Up to
Height* / Width*	1250	2286	2438	2500	1250	2286	2438	2500

Up to	Section	Woodgrain				Micro Profile				
		White	Wood/Trend	RAL	Price	White	Wood/Trend	RAL	Price	
Up to 2050	4 Section	1802	2169	2400	2565	2963	3348	2809	3207	3473
Up to 2204	4 Section	1893	2258	2491	2685	3083	3348	2809	3207	3604
Up to 2320	4 Section	1987	2352	2585	2809	3207	3338	3478		
Up to 2359	5 Section									

Traditional Doors

Traditional Doors are supplied with mock leaded-effect windows as standard, applied to the external face of the window only. Plain windows are available as a no-cost option - please specify your requirement when ordering.

Frames, Hinges & Door leaf Frames

Frames, hinges and door leaf frames in selected Trend colours & wood design are finished in a complementary flat colour: Golden Oak (RAL8003), Rosewood (RAL8016), Night Oak (RAL8014), Winchester (RAL8001), Textured Anthracite (RAL7016), Ice Crystal Grey Aluminium (RAL9007), TT9016 Bling White (RAL9016).

Frames, hinges and door leaf frames are available in smooth finish only.

Prices are for a single colour to all components of the door. If you require a different colour for the frame or hinges to the door panel a surcharge will apply - please contact the office for details.

TREND COLOURS

Flame Red RAL 3000	Fir Green RAL 6009	*White Aluminium RAL 9006
Window Grey RAL 7040	Anthracite Grey RAL 7016	*Grey Aluminium RAL 9007
Quartz Grey RAL 7039	Light Grey RAL 7035	Slate Grey RAL 7015
Steel Blue RAL 5011	Umbra Grey RAL 7022	Cream RAL 9001
Anthracite Textured RAL 7016	Ice Crystal Grey Aluminium	Jet Black RAL9005
Moss Green RAL 6005	Sepia Brown RAL 8014	TT 703 A special satin metallic effect - grey with micaeous iron ore particles.

Colours

Where doors are exposed to direct sunlight, dark colours should be avoided.

RAL references for colours are provided as a guide only to the nearest similar RAL colour. Colours will not match to other RAL finishes due to different coating processes, gloss levels, substrates and textures. Similarly, special RAL, BS, wood effects or other colours will not be a precise match.

*RAL9006 and 9007 pose particular problems when colour matching, more information is available via the sales office.

Colours shown are limited in accuracy by the printing process - samples should always be requested.

If you are matching to other finishes, particularly wood effects such as rosewood, golden oak, night oak or Winchester, always request a sample.

POPULAR OPTIONS

ACCESSORIES AND OPTIONS

Pull Handles Stainless Steel** 38mm 'D' Handles (Length)	1200mm	291 each	Three point locking (Active leaf) Minimum over frame height: 1950mm Horizontal doors 2020mm Vertical doors	483
	1500mm	345 each		
Black Powder Coated Handle Supplied in place of Stainless Steel***		59	Additional Key Each	41
Foot Stops Supplied in place of door stays		FOC	Aluminium Strip Threshold Profile	-50
Over-Size Doors Customer assistance required during delivery		POA	**For how to care for stainless steel see: www.teckentrup.co.uk/garage-doors/frequently-asked-questions-faq/stainless_care ***Black powder coated handles may chip with use.	

POLYMER WINDOWS

WINDOWS - POLYMER DOUBLE GLAZING

Windows construction: Polymer casement with polymer (Styrene Acrylonitrile) double glazed unit.

Georgian



1 Rectangle Plain 1 Rectangle Cross Mullion 1 Rectangle Rhombus

Standard Rib, Centre Rib & Solid



1 Rectangle Plain 1 Rectangle Cross Mullion 1 Rectangle Rhombus Rectangle 2 Rectangle 3 Vertical Square 1 Vertical Square 2 GSA Aluminium

Style	Overall Size	Colour / Finish	Price per Window
Rectangle 1	610 X 270	White Trend/Ral/Wood design	£135 each £177 each
Rectangle 2	680 X 210	White Trend/Ral/Wood design	£135 each £177 each
Rectangle 3	980 X 140	White Trend/Ral/Wood design	£162 each £212 each
Square 1 & 2	270 x 270	White Trend/Ral/Wood design	£135 each £177 each
GSA Aluminium Window Section	per linear m	White/Trend Ral/Wood design	POA POA

All polymer windows are available with these glazing options:



Clear



Frosted



Satin

Polymer Windows

To price for windows fitted vertically down the door; square type 1 & 2, match windows to number of sections ie 4 sections = 4 windows).

Selected Trend colours & wood design windows are finished in a complementary flat colour for Golden Oak (RAL8003), Rosewood (RAL8016), Night Oak (RAL8014), Winchester RAL (8001), Textured Anthracite (RAL7016), Ice Crystal Grey Aluminium (RAL9007) and TT9016 Bling White (RAL9016).

The surrounds on aluminium GSA window sections are finished in a smooth finish. Window frame colour shade and surface lustre will show a variance from the panel finish as the base material and coating methods are different.

ALUMINIUM WINDOWS & DECALS

ALUMINIUM WINDOWS - POLYMER DOUBLE GLAZING

Windows construction: Aluminium and polymer casement with polymer double glazed unit.

Alpha 280mm x 280mm Sigma 610mm x 200mm Zeta ø280mm Gamma 534mm x 344mm

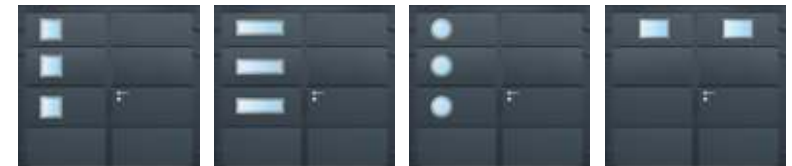

PRICE PER WINDOW

£333

Kappa 1860mm x 180mm Athena 406mm x 203mm Versus 900mm x 1000mm

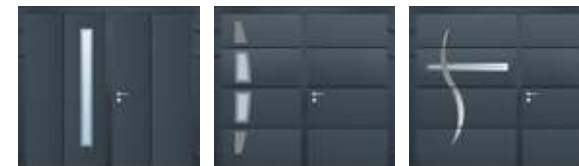

PRICE PER WINDOW

£800

Minimum over frame height for Kappa windows used vertically on side hinged doors: 2010mm



Satin Clear
All aluminium windows are available with these glazing options (satin is supplied as standard).

ALUNOX DECALS

Factory bonded alunox decals. Decals can be positioned to requested positions, however, popular arrangements are shown here.

Access 1 431mm x 40mm Access 2 430mm x 40mm Access 3 215mm x 40mm Access 4 400mm x 86mm Access 5 180mm x 180mm



PRICE PER DECAL

£57

Access 6 70mm x 70mm Access 7 150mm x 150mm Access 8 194 mm x 194 mm Access 9 436mm x 40mm Access 10 431mm x 13mm

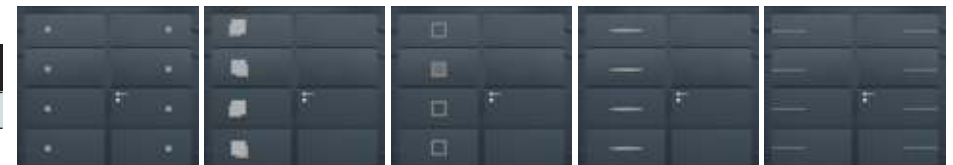

PRICE PER DECAL

£57

Writing 100mm 200mm

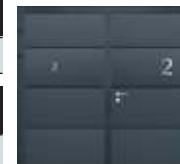

PRICE PER DECAL

100mm £52

PRICE PER DECAL

200mm £57

EXTRA OPTIONS

EXTRA TOUCHES



PET FLAP

£45 fitting charge*

*Customer supplied



CODE LOCK

£603



Smart Lock

£525

Bluetooth



Smart Upgrade

£84

Apple Home Kit / Alexa

SPY HOLE

£52

LETTER box

From £78

TECHNICAL CARTECK SECTIONAL GARAGE DOORS GSW 40-L & GSA/SLX VISION

DIMENSIONS ORDERING SIZES = DRIVE THROUGH SIZES

Observe the following measurement details to guarantee exact assembly and precise, reliable operation of CarTeck sectional garage doors.

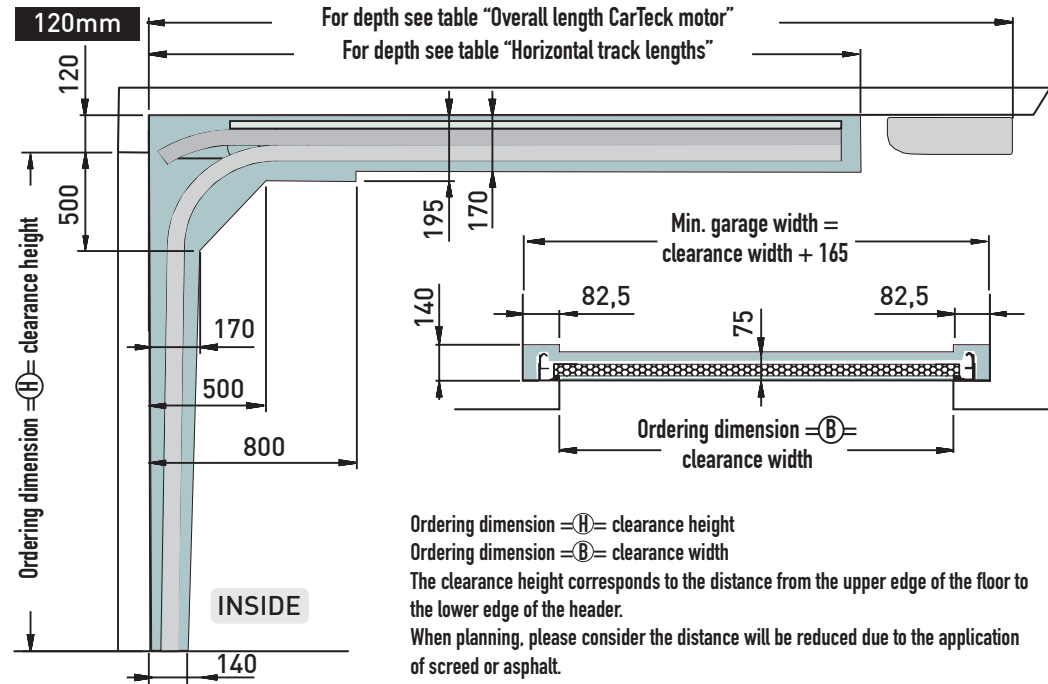

ORDERING NOTES:

Door heights achieved by mixing panel heights (except ribbed), use of 0, 9, 17, or 32mm bottom profiles or top & bottom panel cut downs.
When ordering use metric sizes, imperial conversions are nominal.

Frame holes & fixing brackets

		Width																			
Height		2084	2134	2235	2286	2388	2438	2591	2743	3048	3353	3658	3962	4216	4267	4420	4572	4877	5182	5500	Height
3000																					3000
2875																					2875
2750																					2750
2625																					2625
2500																					2500
2375																					2375
2250																					2250
2204																					2204
2175																					2175
2125																					2125
2084																					2084
2050																					2050
2000																					2000
1925																					1925
1875																					1875
Height		2084	2134	2235	2286	2388	2438	2591	2743	3048	3353	3658	3962	4216	4267	4420	4572	4877	5182	5500	Height
		Width																			

Requires frame leg holes (standard frame) and twist fix frame leg brackets.

Twist fix frame leg brackets not required.

Twist fix frame leg brackets required.

No holes in frame leg as an option (between fix frame with stiffener brackets required).

No holes in frame leg as an option (between fix frame with stiffener brackets required).

RECOMMENDED HORIZONTAL TRACK FIXING POINTS

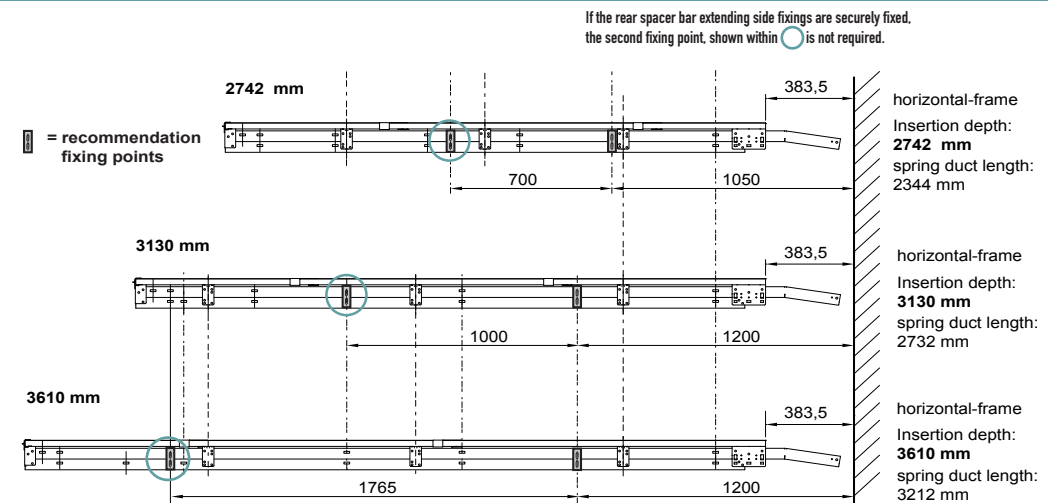

HORIZONTAL TRACK LENGTHS

Allow 115mm headroom. Use standard lifting gear. Allow 140mm headroom above trays only. Gear uses twin springing & commercial roller spindles

		Width																			
Height		2084	2134	2235	2286	2388	2438	2591	2743	3048	3353	3658	3962	4216	4267	4420	4572	4877	5182	5500	Height
3000																					3000
2875																					2875
2750																					2750
2625																					2625
2500																					2500
2375																					2375
2250																					2250
2204																					2204
2175																					2175
2125																					2125
2084																					2084
2050																					2050
2000																					2000
1925																					1925
1875																					1875
Height		2084	2134	2235	2286	2388	2438	2591	2743	3048	3353	3658	3962	4216	4267	4420	4572	4877	5182	5500	Height
		Width																			

3610mm

3130mm

2742mm

SPECIFICATION

GSW 40-L Sectional door

DOOR:

Sectional door double skinned PUR foam core, 40mm thick CarTeck panels. Outer surface finished in choice of 4 standard designs and all standard listed CarTeck colours. Inner surface stucco design, colour similar to RAL 9002. Sections have a centre seal; EPDM, header, and floor seals. Different order heights are made up from mixing panel sizes, 4 different bottom profile sizes and reduced top panel heights.

FRAME:

Door frame is made from galvanized sheet steel, coil coated with polyester, prime coated similar to RAL 9016 or other Trend colour. Protective strips with EPDM sealing lips on both sides of the vertical tracks.

HARDWARE:

Galvanised finish, screwed hinges to all sections, adjustable rollers with ball bearings. Multiple tension springs and double cable system housed in low friction housing above horizontal tracks.

AUTOMATION:

Door prepared for automation as standard with manual locking available as optional extra.

COLOURS

RAL references for colours are provided as a guide only to the nearest similar RAL colour. Colours will not match to other RAL finishes due to different coating processes, gloss levels, substrates and textures. Similarly, special RAL, BS or other colours will not be a precise match.

The door panel, frames and window frame colour shade, and surface lustre will show some slight variation, this is due to different base materials and coating methods.

GSA / SLX Vision Sectional door

DOOR:

Sectional door panels made from hollow aluminium profiles, 40mm depth filled with 16mm scratch resistant, polymer double glazing. Sections have a centre seal; EPDM, header, and floor seals. Door heights are achieved by equal division of panel heights ranging from 300mm to 750mm.

FRAME:

Door frame is made from galvanized sheet steel, coil coated with polyester, prime coated similar to RAL 9016 or other Trend colour. Protective strips with EPDM sealing lips on both sides of the vertical tracks.

HARDWARE:

Hardware, galvanised finish, screwed hinges to all sections, adjustable rollers with ball bearings. Multiple tension springs and double cable system housed in low friction housing above horizontal tracks.

AUTOMATION:

Door prepared for automation as standard.

COLOURS

RAL references for colours are provided as a guide only to the nearest similar RAL colour. Colours will not match to other RAL finishes due to different coating processes, gloss levels, substrates and textures. Similarly, special RAL, BS or other colours will not be a precise match.

The door panel, frames and window frame colour shade, and surface lustre will show some slight variation, this is due to different base materials and coating methods.

NO HOLES FRAME FIXING



IMPORTANT !

When fixing a no-holes frame between the reveal you must secure the frame to the lintel as shown using the 'L' bracket supplied. This is pre-fitted to all no-holes frame legs.

If a good fixing cannot be achieved, alternative fixing methods must be used to secure the frame.



CARTECK DRIVE 500 / 600 DIMENSIONS

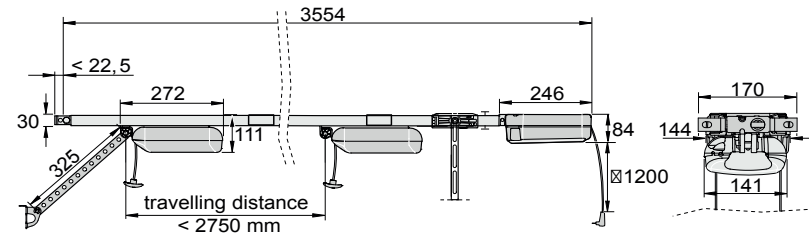

CARTECK DRIVE PRO 500 / 600 DIMENSIONS

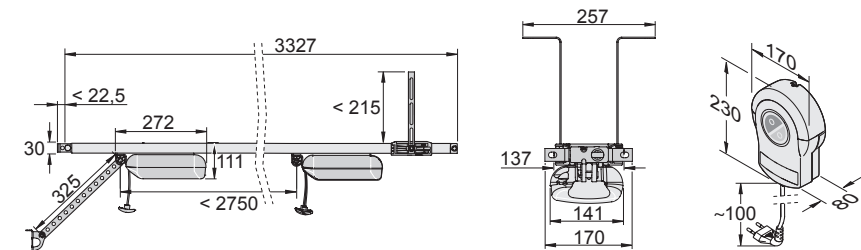

OPERATOR RAIL FOR CARTECK 260/70/80 & 360/370/380

Turning motor head through 90 degrees reduces overall length: 200 series -133mm 300 series -18mm

Height	Carteck 260 / 360				Carteck 270 / 370				Carteck 280 / 380												Height
	2084	2134	2235	2286	2388	2438	2591	2743	3048	3353	3658	3962	4216	4267	4420	4572	4877	5182	5500		
3000	4296mm																		3000		
2875	3536mm																		2875		
2750	3286mm																		2750		
2625	3286mm																		2625		
2500	3286mm																		2500		
2375	3286mm																		2375		
2250	3286mm																		2250		
2204	3286mm																		2204		
2175	3286mm																		2175		
2125	3286mm																		2125		
2084	3286mm																		2084		
2050	3286mm																		2050		
2000	3286mm																		2000		
1925	3286mm																		1925		
1875	3286mm																		1875		

OPERATOR RAIL FOR CARTECK DRIVE & DRIVE PRO

Height	Width																				Height
	2084	2134	2235	2286	2388	2438	2591	2743	3048	3353	3658	3962	4216	4267	4420	4572	4877	5182	5500		
3000	Drive 4650mm Drive Pro 4423mm																		3000		
2875	Drive 4650mm Drive Pro 4423mm																		2875		
2750	Drive 4650mm Drive Pro 4423mm																		2750		
2625	Drive 4650mm Drive Pro 4423mm																		2625		
2500	Drive 4650mm Drive Pro 4423mm																		2500		
2375	Drive 4650mm Drive Pro 4423mm																		2375		
2250	Drive 4650mm Drive Pro 4423mm																		2250		
2204	Drive 4650mm Drive Pro 4423mm																		2204		
2175	Drive 4650mm Drive Pro 4423mm																		2175		
2125	Drive 4650mm Drive Pro 4423mm																		2125		
2084	Drive 3554mm Drive Pro 3327mm																		2084		
2050	Drive 3554mm Drive Pro 3327mm																		2050		
2000	Drive 3554mm Drive Pro 3327mm																		2000		
1925	Drive 3554mm Drive Pro 3327mm																		1925		
1875	Drive 3554mm Drive Pro 3327mm																		1875		

TECHNICAL CARTECK SUPER SIZE SECTIONAL GARAGE DOORS GSW 40-L

DIMENSIONS AND CLEARANCES

N - Normal fitting

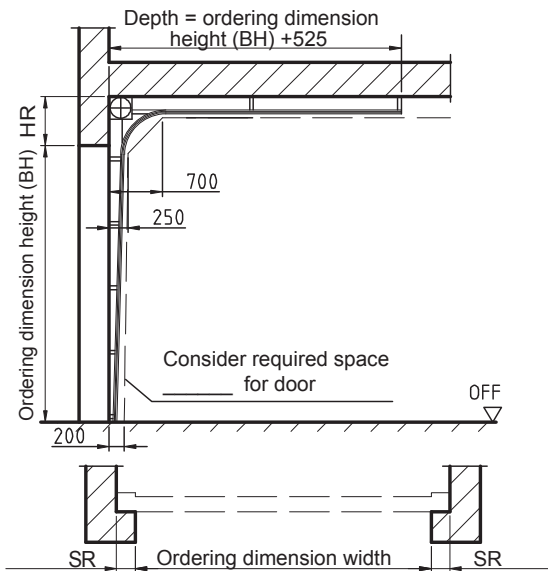

SR= side room with rail motor = 110
 SR= side room non-drive side with direct drive motor = 110
 SR= side room drive side with direct drive motor = 210

NSH - Low headroom fitting

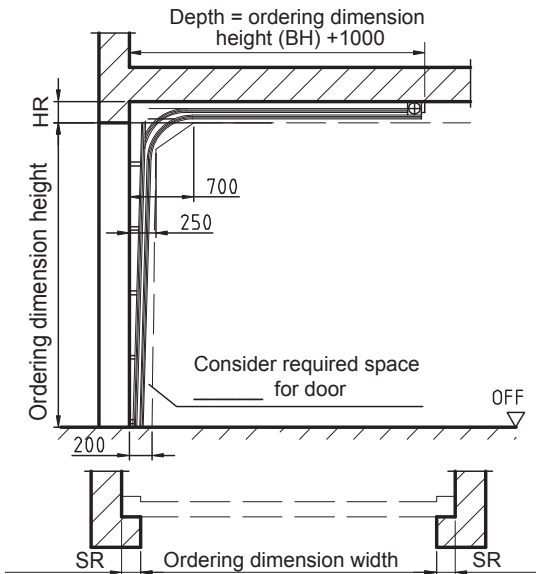

SR= side room with rail motor = 120
 SR= side room non-drive side with direct drive motor = 120
 SR= side room drive side with direct drive motor = 210

HR HEADROOM REQUIREMENT

Heights				Widths				
				6000	6500	7000	7500	8000
4 Sections	2250 7'4"	Rail Operator	Stand Headroom	400	450	-	-	-
		Direct Drive	Stand Headroom	400	450	450	450	450
			Low Headroom	280	280	-	-	-
			Low Headroom	250	250	250	250	250
5 Sections	2750 9'0"	Direct Drive	Stand Headroom	400	450	450	450	450
			Low Headroom	250	250	250	250	250
6 Sections	3000 9'9"	Direct Drive	Stand Headroom	400	450	450	450	450
			Low Headroom	250	250	250	250	250

Max Width For Low Headroom = 7750

280mm low headroom with rail operator is to prevent the top panel seal rubbing on the rail
 If this is not an issue then the door will fit in 250mm

SPECIFICATION

DOOR:

Sectional door double skinned PUR foam core, 40mm thick CarTeck panels. Outer surface finished in choice of 4 standard designs and all standard listed CarTeck colours. Inner surface stucco design, colour similar to RAL 9002. Sections have a centre seal, EPDM, header, and floor seals. Different order heights are made up from mixing panel sizes, 2 different bottom profile sizes and reduced top panel heights. Doors have reinforcing steel profiles on the rear of the panels.

FRAME:

Door frame is made from hot dipped galvanised steel sections. Protective strips with EPDM sealing lips on both sides of the vertical tracks.

HARDWARE:

Doors have galvanised frame legs and are supplied without a header strip. Hardware has galvanised finish, screwed hinges to all sections, adjustable rollers with ball bearings. Front or optional rear mounted torsion spring with load-bearing steel cables.

AUTOMATION:

Electric 230V drive as standard, either direct or rail drive. Optical safety edge, hard wired to control system and photocells. Direct drive motor must have 13 amp supply direct to consumer unit. External release is not possible with direct drive motor, additional access must be available into garage.

COLOURS

RAL references for colours are provided as a guide only to the nearest similar RAL colour. Colours will not match to other RAL finishes due to different coating processes, gloss levels, substrates and textures. Similarly, special RAL, BS or other colours will not be a precise match.

The door panel, frames and window frame colour shade, and surface lustre will show some slight variation, this is due to different base materials and coating methods.

TECHNICAL CARTECK SIDE HINGED GARAGE DOORS GSW 40-L

GEORGIAN DOORS

Horizontal doors have 2 columns of features as standard arranged 1/2 - 1/2, changing to an asymmetric three columns at the width shown below. 1/2 - 1/2 vertical doors have 2 rows of features as standard changing to three at the height shown right.

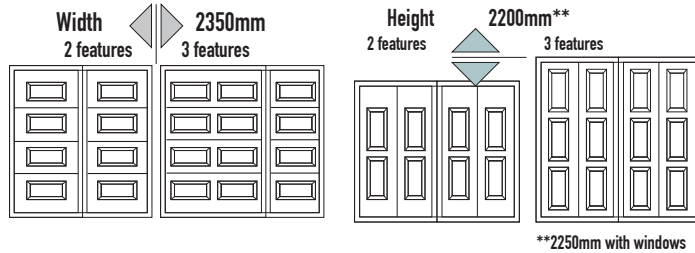

SPECIFICATION

DOOR:

Door leaves are fabricated using 40mm thick CarTeck panels with an extruded aluminium perimeter frame and integral seals. Doors with the optional standard threshold profile have an EPDM black threshold seal at the base. Each leaf is fitted with two or three (dependent on size) surface fixed hinges.

The door frame is an extruded aluminium profile with mitred corners and integral seals, for details refer to technical leaflet. A 3-part stepped aluminium threshold is also included. 10mm tolerance should be allowed to facilitate frame squaring during installation.

HARDWARE:

Hardware comprises of a DIN standard CE marked European sashlock and a pair of stainless steel round bar lever handles on 50mm diameter roses. A Euro-profile cylinder and thumb turn with stainless steel escutcheons is included as standard (double cylinder, key both sides is available as an option if required). Two security keys are supplied with each cylinder. The inactive leaf is fitted with top and bottom recessed lever action flush bolts. A stay is fitted to each leaf to hold the door in the open position, any leaf below 780mm wide (including asymmetric side hinged doors) will not have a stay.

Stainless steel** needs regular cleaning or will stain, especially in areas of high salt content.

COLOUR:

The door frame and window frame colour shade and surface lustre will show a variance from the panel finish as the base material and coating methods are different. Where differing materials and process are adopted, such as side hinged GSW 40L garage doors, there may be some colour matching variations. Differing light conditions may further reduce or highlight this effect. The colours RAL9006 and 9007 pose particular problems when colour matching, more information is available via the sales office.

RAL references for colours are provided as a guide only to the nearest similar RAL colour. Colours will not match to other RAL finishes due to different coating processes, gloss levels, substrates and textures. Similarly, special RAL, BS or other colours will not be a precise match.

**For how to care for stainless steel see: www.teckentrup.co.uk/garage-doors/frequently-asked-questions-faqs

DIMENSIONS AND CLEARANCES

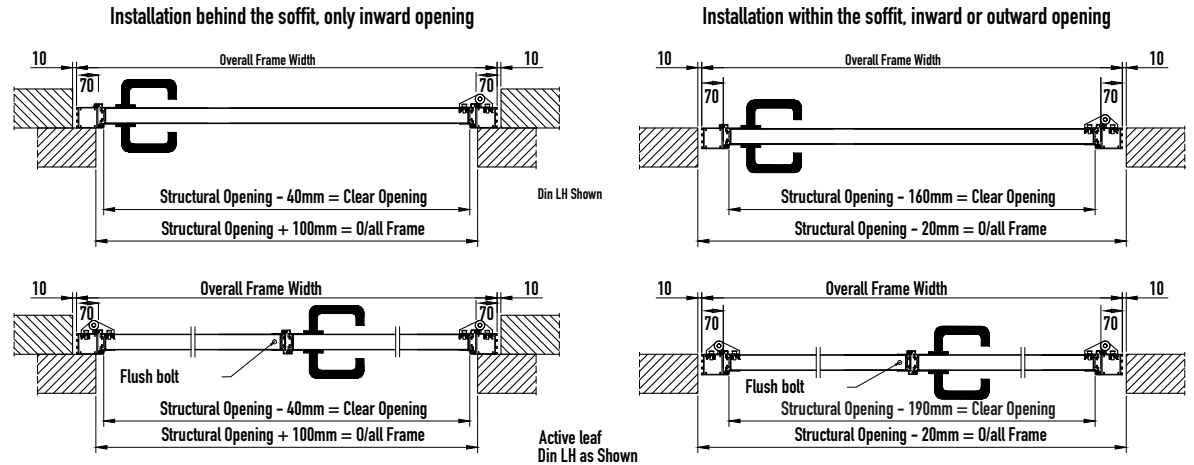

CLEARANCES

IMPORTANT

When doors are ordered as a structural opening size, Teckentrup UK will deduct 20mm from the width and 10mm from the height for coursing tolerance. If this is more tolerance than you wish, please state the over-frame dimension you require.



The section height and the height of the handle 'x' depend on the actual door height and construction of the door.

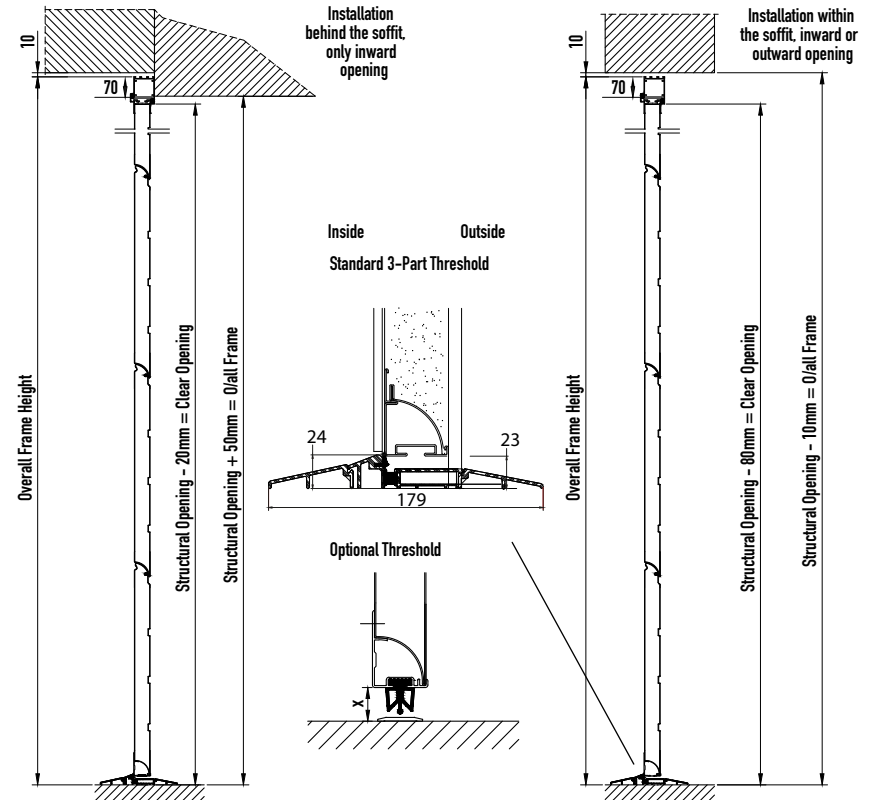

GENERAL SPARES

GENERAL SPARES		
	Price	Per
SECTIONAL		
Bottom rubber	24	m
Side seals	29	ea
Top seal	12	m
Bottom profile 0mm	29	m
Bottom profile 9mm	36	m
Bottom profile 17mm	42	m
Bottom profile 32mm	56	m
Top panel cut down profile	29	m
Bottom panel cut down profile	29	m
Panels use width of 4 section equivalent	20%	of total door price
Legs	230	ea
Horizontal Tracks	202	ea
Tray covers	70	ea
Spacer bars	29	m
Headers	36	m
Cables	70	pr
Springs	29	ea
Spring clips	10	ea
Rollers/pulleys/shreave wheels	16	ea
Spring tensioners (thread/nuts/hooks)	29	ea
Intermediate brackets	42	ea
Bottom brackets	42	ea
Centre hinges	15	ea
Top roller bracket including roller	42	ea
SIDE HINGED		
Raised threshold (including internal & external ramps)	126	m
Door stay (header bracket not included)	126	ea
Door stay header bracket white	11	ea
Door stay header bracket coloured	27	ea
Door stay grease pack of 20	11	ea
WINDOWS		
Window front white	56	ea
Window front painted	109	ea
Window glass (polymer)	56	ea
Window back	56	ea
Windows screws (14)	10	pk

Teckentrup is a family business with operations throughout the world. In the UK Teckentrup is based in Warrington, Cheshire. Teckentrup products are available through a national network of independent Garage Door Specialist installers.

Teckentrup offers more than garage doors: We provide solutions and have set three quality standards for our garage doors:

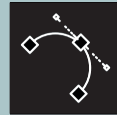

Design

We combine ease of use with aesthetics.

Good design uses innovative technology to make using a product intuitive and effortless. Teckentrup garage doors offer a wide range of design options that will transform the look of your home and the way you use your garage space.



Safety & Security

We combine security with safety.

Our products are designed to provide peace of mind with both physical security and the knowledge that durability and safe operation are inherent.



Service

We combine speed with reliability.

The Teckentrup team and our network of Garage Door Specialist installers love to make your new door a pleasure to own. You'll always receive expert advice and the best service for installation, maintenance and aftercare.

**Teckentrup UK Limited,
Units 2-4 Opus 9 Industrial Estate,
Woburn Road, Winwick Quay Warrington WA2 8UE**

www.teckentrup.co.uk
t: 01925 924 050
f: 08701 314 843
e: sales@teckentrup.co.uk

TECKENTRUP
DOOR SOLUTIONS

Design. Security. Service.

Quality & Environment

Teckentrup operates to quality procedures audited to ISO 9001.

We care about the environment too - this is why our products are certified in accordance with the Environmental Product Declaration (EPD).

ISO 14001 Environmental Management
ISO 50001 Energy Management



DGNB
Deutsche Gesellschaft für Nachhaltiges Bauen e. V. German Sustainable Building Council

BNB
Bewertungssystem Nachhaltiges Bauen - Evaluation system for sustainable building

LEED
Leadership in Energy and Environmental Design

BREEAM
Building Research Establishment Environmental Assessment Methodology



Raising Standards
Safety Assured
Member



CONTRACTOR HEALTH & SAFETY ASSESSMENT SCHEME
Accredited Contractor
www.has.co.uk



NBS Source



LPCB Red Book
LPCB



Constructionline